

Description

The SU680-08 SingleSense® single-use, flow-through pH sensor is designed for downstream applications where the pH must be continuously measured in process media flowing through 1/2-inch flexible tubing.

Rugged and always ready to use, no hydration time is required. The sensor can be rotated into the buffer storage chamber for a 1-point standardization check or to avoid exposure to CIP process solution.

Model	SU680 Series
Part Number	SU680-08

Sensor Specifications

Measurement Range	2–12 pH
Operational Temp. Range	15°–50° C [60°–122° F]
Storage Temperature	5°–35° C [41°–95° F]
Shelf Life	36 months Post Gamma: 30 months
Gamma Tolerance Level	50 kGy
Sensor/Tubing Interface	1/2-inch Hose Barbs
Sensor Connector Cable	8-pin Variopin

Wetted Materials

Main Sensor Body	PEEK, USP Class VI, ADI Free
Port Gasket	Dimethyl Silicone Rubber Pt Cure, USP Class VI, ADI Free
O-ring	EPDM, USP Class VI, FDA Compliant Extraction Tested 21CFR, 177.2600, ADI Free
pH Glass Electrode	Lead-free Glass
Ceramic Junction	Alumina Silicate
Hose Barbs	HDPE, USP Class VI

Features

- pH sensor rotates into the buffer storage chamber in the sensor body for long-term storage
- Only the sensor rotates out of flow path, keeping flow path open
- Sensor can be rotated multiple times without loss of buffer storage electrolyte in the flow stream

Benefits

- Sensor can be stored and protected from exposure to CIP solutions
- Always ready to use; no rehydration time required
- Sensor can be rotated into buffer storage chamber during mid-run for 1-point standardization check



Isometric View

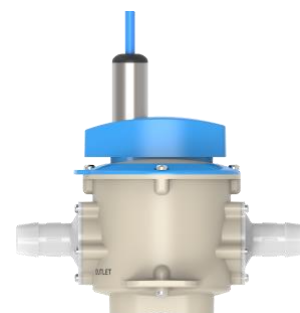

Side View

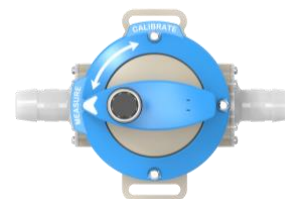

Top View with Dial Face

Dimensional Drawings of SU680-08

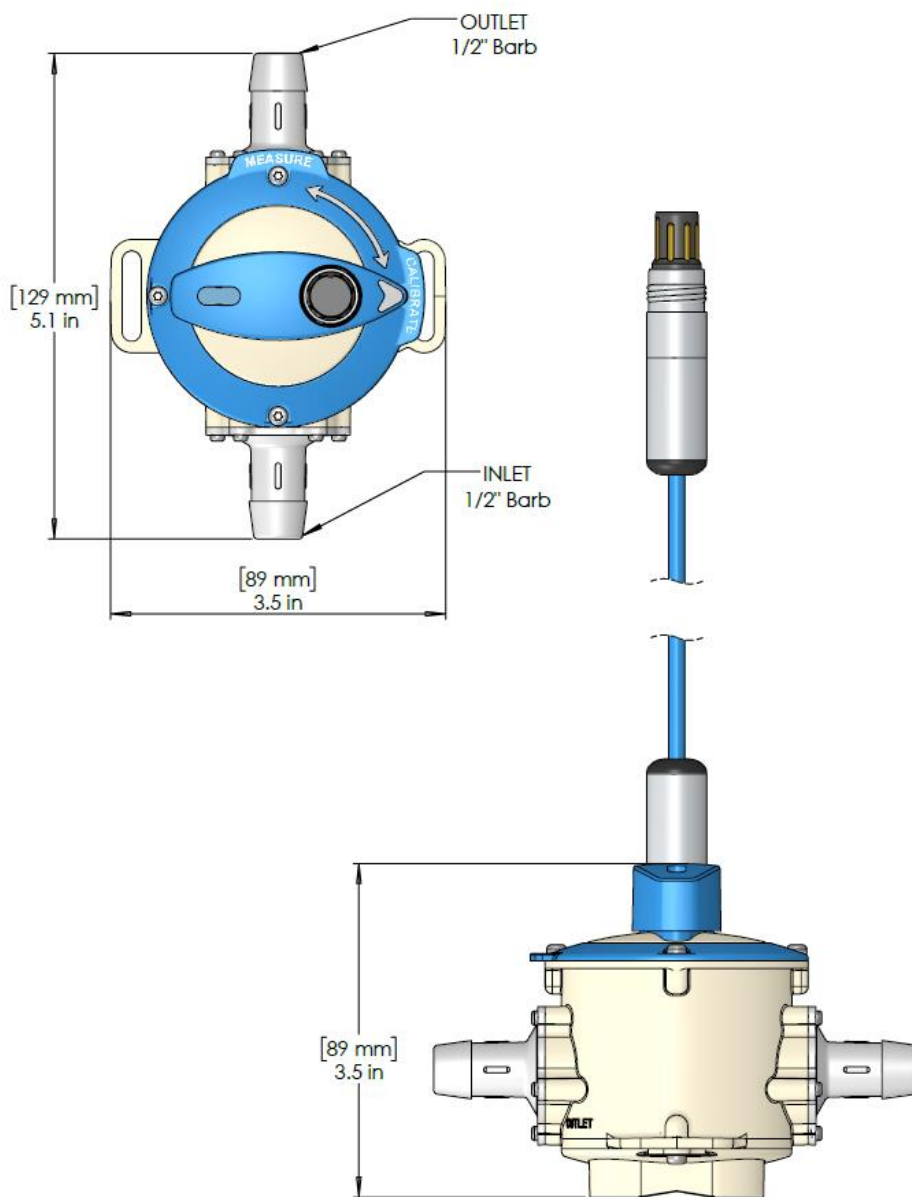

The contents of this publication are presented for information purposes only, and while every effort has been made to ensure their accuracy, they are not to be construed as warranties or guarantees, express or implied, regarding products or services described herein or in their use or applicability. All sales are governed by our terms and conditions, which are available on request. We reserve the right to modify or improve the design or specification of such products at any time.

Doc Nbr: PSS-082104 R3

Published 27 July 2023

© July 2023 Broadley-James Corporation. All rights reserved. Visit www.broadley-james.com/trademarks for trademark information.

TMP-PSS-102101 R1